



OWNER'S MANUAL

**Read and understand this entire manual before riding!
DO NOT RETURN TO STORE!**

This does not affect your statutory rights.

NOTE: Manual illustrations are for demonstration purposes only. Illustrations may not reflect exact appearance of actual product. Specifications subject to change without notice.

Please have your 21 character product I.D. code ready before contacting Razor for warranty assistance and/or replacement parts.

Product I.D. Code: _____ - _____ - _____

CONTENTS

Safety Warnings	1-2	Repair and Maintenance.....	4
Before You Begin.....	2	Check Before Riding.....	5
Assembly Instructions.....	3	Safety Reminders/Warranty.....	7

SAFETY WARNINGS

AN IMPORTANT MESSAGE TO PARENTS: This manual contains important information. For your child's safety, it is your responsibility to review this information with your child and make sure that your child understands all warnings, cautions, instructions and safety topics. Razor USA recommends that you periodically review and reinforce the information in this manual with younger riders, and that you are required to inspect and maintain your child's scooter to insure their safety.

! GENERAL WARNING: Scooter riding can be a hazardous activity. Scooters can and are intended to move, and it is therefore possible to get into dangerous situations and/or lose control and/or fall. If such things occur you can be seriously injured or die. LIKE ANY OTHER MOVING PRODUCT, USING A SCOOTER CAN BE A DANGEROUS ACTIVITY AND MAY RESULT IN INJURY OR DEATH EVEN WHEN USED WITH PROPER SAFETY PRECAUTIONS. USE AT YOUR OWN RISK AND USE COMMON SENSE.

! WARNING: RDS OFF-ROAD DIRT SCOOTER IS DIFFERENT IN MANY WAYS. This scooter has inflatable tires, not solid tires like more basic kick scooters might have. Jumping and hard riding places greater stresses on tires, wheels and components. Razor recommends maximum rider weight for performing such aggressive riding to not exceed 120 lb (54 kg) on the RDS scooter.

This scooter was manufactured for performance and durability, but it is not impervious to damage. Trick riding can overstress or damage any product, including this scooter, and the rider assumes all risks associated with high-stress activity. Riders who may intend to use this scooter to ride "off road" must be talented and experienced scooter riders able to handle the higher levels of risk and the higher degrees of expertise associated with such riding. Safety equipment such as helmet (with chinstrap fastened), knee pads and elbow pads are always recommended because they may provide protection against the most common types of impact circumstances.

! WARNING: SAFE RIDING PRACTICES ARE ALWAYS IMPORTANT

- Always wear safety equipment, such as helmet, knee pads and elbow pads. Always wear a helmet when riding your scooter and keep the chinstrap securely buckled.
- Always wear shoes.
- Ride on smooth surfaces away from motor vehicles.
- When riding off road, be careful of broken glass, sharp objects or other debris that may puncture or damage your tires and inner tubes. Select off-road riding locations free of such dangerous materials.
- Avoid soft patches of dirt or loose gravel while riding. Scooter may lose traction and cause rider to fall.
- Avoid sharp bumps, drainage grates and sudden surface changes. Scooter may suddenly stop.
- Avoid riding on wet surfaces; weather impairs traction, braking and visibility.
- Do not ride at night.
- Brake will get hot from continuous use. Do not touch after braking.
- Avoid excessive speed associated with downhill rides.

- Adults must assist children in the initial adjustment procedures to assemble the scooter.
- Obey all local traffic and scootering laws and regulations.
- Watch out for pedestrians.
- Check and secure all fasteners before every ride.
- Replace worn or broken parts immediately.
- Always be sure to check tires for excessive wear or damage before riding.
- Do not exceed the tires PSI rating. Over inflation will cause a rupture.
- Do not exceed 220 lb (100 kg) under normal riding circumstances and 120 lb (54 kg) under off-road conditions involving aggressive riding practices.
- Do not allow children under age ten (10) to use the RDS scooter. All children and preteens should ride with adult guidance at all times.
- Rider weight does not necessarily mean a child's size is appropriate to fit or maintain control of the scooter.
- A parent's decision to allow his or her child to ride this product should be based on the child's maturity, skill and ability to follow rules.

ACCEPTABLE RIDING PRACTICES AND CONDITIONS

Adult supervision is recommended. Scooters are meant to be used only in controlled environments free of potential traffic hazards and not on public streets. Do not allow your child to ride a scooter in any areas where vehicle traffic is present. Child must maintain a hold of the handlebars at all times. Never allow more than one child at a time to ride a scooter. Never use near steps, sloped driveways, hills, roadways, alleys or swimming pool areas.

Do not ride a scooter in wet weather. Scooters function best on solid, flat, dry surfaces such as pavement or level ground without loose debris such as rocks or gravel. Wet, slick or uneven and rough surfaces may impair traction and contribute to possible accidents. Do not ride a scooter in mud, ice, puddles or water. Never risk damaging surfaces, such as carpet or flooring, by use of a scooter indoors. Do not ride at night or when visibility is impaired.

TRICK AND OFF-ROAD RIDING PRESENTS ADDITIONAL RISKS TO RIDERS AND EQUIPMENT: No scooter, not even this one, is impervious to damage. Off-road and trick riding obviously increases risks of rider falls and of product damage due to stresses, impacts or wear, and riders assume all risks associated with high-stress activities:

- Riding in "off-road" conditions can present obstacles, surfaces and conditions potentially more difficult to master than "ordinary" smooth or paved surfaces.
- Check your scooter before every ride, and replace worn or broken parts immediately.
- Trick and off-road riding requires skill and practice; it is not "automatic". Just because you may see people on TV, the internet or in your neighborhood doing tricks or stunts, that does not mean you can do the same without learning or without risk. Take your time, be careful, make progress at your own pace and always be aware of the difficulty and risk involved in what you are trying to accomplish.
- Always visually review off-road riding terrain before riding, in order to try to minimize encounters with "unknown" impediments in your path without time to react or compensate.

SAFETY WARNINGS

PROPER RIDING ATTIRE

Always ensure rider is wearing proper protective equipment, such as an approved safety helmet. A helmet may be legally required by local law or regulation in your area. Always wear shoes and keep shoelaces tied and out of the way of the wheels. Never ride barefoot or in sandals.

FAILURE TO USE COMMON SENSE AND HEED THE ABOVE WARNINGS FURTHER INCREASES RISK OF SERIOUS INJURY. USE AT YOUR OWN RISK AND WITH APPROPRIATE AND SERIOUS ATTENTION TO SAFE OPERATION. USE CAUTION.

⚠ WARNING: ALWAYS INSPECT SCOOTER PRIOR TO RIDING. Properly inspecting and maintaining your scooter can reduce the risk of injury. Always inspect your scooter before riding and regularly maintain it.

⚠ WARNING: CHECK LOCAL LAWS REGARDING SCOOTER USE. Check local laws and regulations to see where and how you may use your Razor scooter legally. In many states and local areas scooter riders are required BY LAW to wear a helmet. Check local laws and regulations regarding laws governing helmet use and scooter operation in your area.

BEFORE YOU BEGIN

Remove the contents from box. Inspect the contents of the box for scratches in the paint and/or dents that may have occurred during shipping. Because your scooter was partially assembled and packed at the factory, there should not be any problems, even if the box has a few scars or dents.

⚠ WARNING: DO NOT USE NON-RAZOR PRODUCTS WITH YOUR SCOOTER. The RDS has been built to certain Razor design specifications. The original equipment supplied at the time of sale was selected on the basis of its compatibility with the frame, fork and all other parts. Certain aftermarket products may not be compatible and will void your warranty.

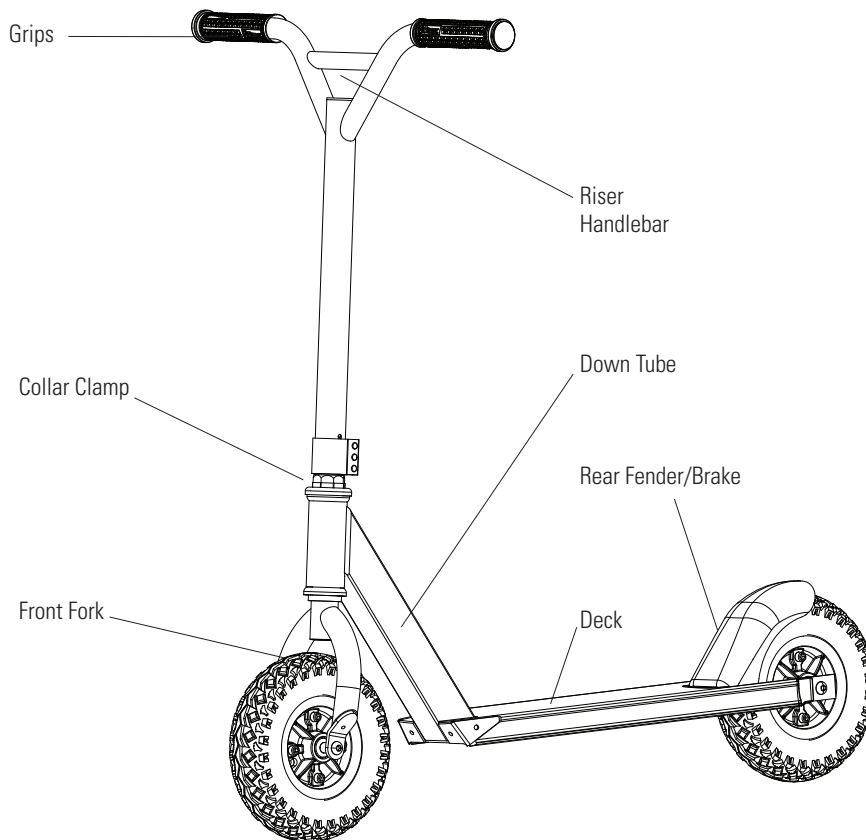

PRODUCT I.D. CODE

1. Side of deck
2. UPC Side of Box

❑ Required Tools For Assembly

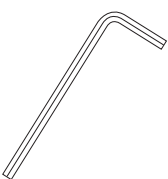

5 mm Allen wrench
(Included)

ASSEMBLY INSTRUCTIONS

□ Attaching the Handlebar

Tools Required: 5 mm Allen Wrench

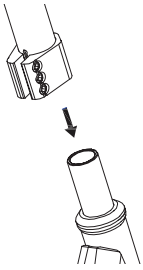

1 Using a 5 mm Allen wrench, loosen the bolts on the collar clamp and slide clamp upward on the handlebar. With a twisting motion, push the handlebar onto the fork until it bottoms out on the fork headset lock nut.

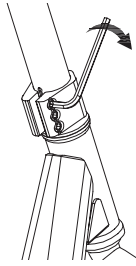

2 With the front wheel pointed straight ahead, the handlebars square to the front wheel and the Razor logo facing the front, tighten the clamp as shown. Alternately tighten each bolt until securely tightened.

! WARNING: Failure to properly install and tighten the clamp may cause the rider to lose control and fall. If you are having difficulty understanding these instructions, please contact Razor Customer Service for assistance.

□ Inflating Tires

The tires are inflated when shipped, but it invariably may lose some pressure between the point of manufacturing and your purchase. Always inflate tire to the correct PSI before first time use.

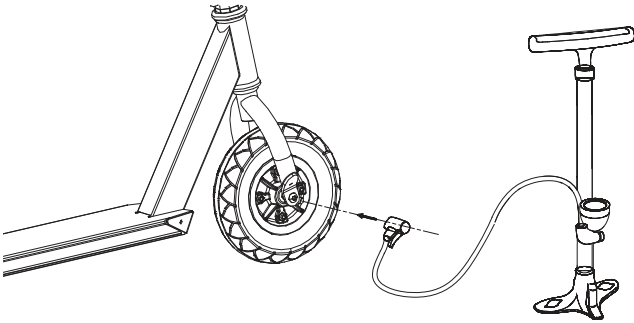

1 Using a bicycle-style tire pump equipped for a Schrader-type valve, inflate the front tire to the correct PSI indicated on the sidewall of the tire.

! WARNING: Inflate the tires to the recommended pressure (60 PSI) before riding. Do not exceed the tires' PSI rating. Over inflation will cause a rupture and under inflation may cause additional wear on the tire.

REPAIR AND MAINTENANCE

❑ Replacing the Tires/Tubes

Tools Required: 5 mm Allen Wrench

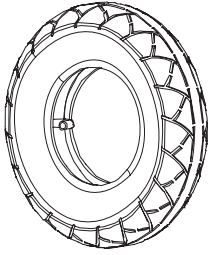

1 Completely deflate the tire. Use a 5 mm Allen wrench to remove the four bolts on the hub. Remove the worn/damaged tire or inner tube and replace it with a new one.

Note: Be careful not to lose the four nuts on the opposite side of the hub.

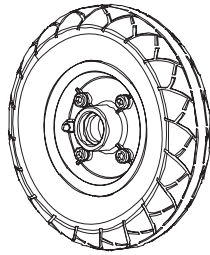

2 Assemble the hub using the diagram at right. Tighten bolts using 5 mm Allen wrench. Re-inflate. (Do not exceed 60 PSI.)

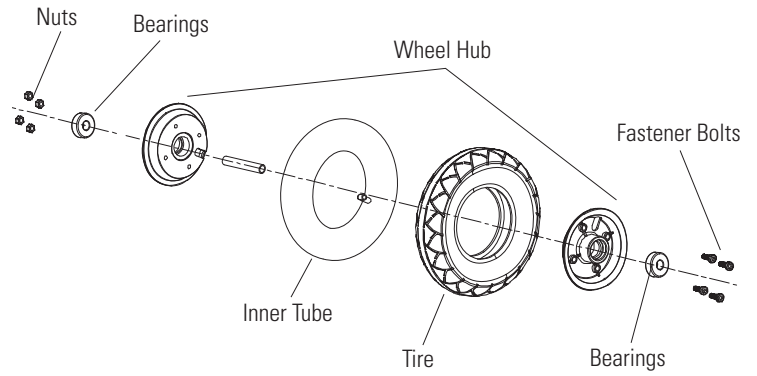

❑ Replacing the Wheels

Tools Required: 5 mm Allen Wrench

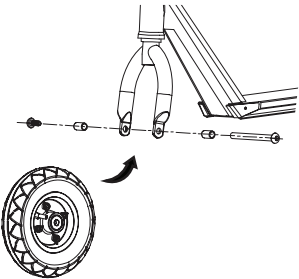

1 Front wheel sequence.

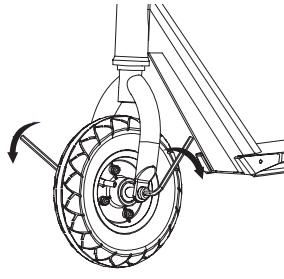

2 Securely tighten the bolt as shown.

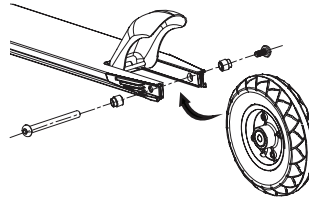

3 Rear wheel sequence.

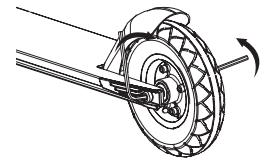

4 Securely tighten the bolt as shown.

CHECK BEFORE RIDING

❑ Collar Clamp

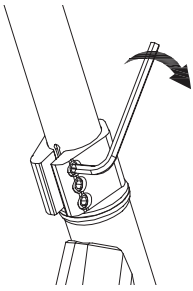

Using a 5 mm Allen wrench, check that the clamp bolts are tightened securely. Check the pressure of your tires and inspect them for any signs of damage. Check your front and rear bolts to ensure they are tight.

❑ Tires

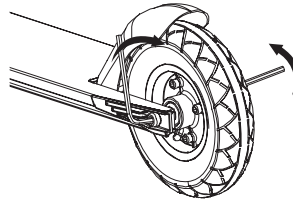
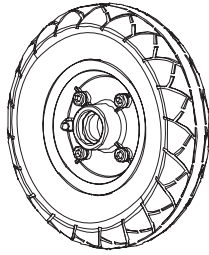

❑ Wheels and Bearings

It is the responsibility of the owner or guardian to periodically inspect the wheels for wear and tear, the axle for proper tightness, and bearings for side-to-side play and loose parts. When a wheel or wheel bearing develops play, this is an indication of excess wear and replacement is necessary. Replace immediately with only genuine Razor replacement wheels. Worn wheels/bearings are considered normal wear and tear and are not covered by the Warranty. Other manufacturers' wheels may not be compatible with your RDS scooter, may affect your safety and will void your warranty.

❑ Cleaning Your Scooter

Wipe with a damp cloth to remove dirt and dust.

Do not use industrial cleaners or solvents as they may damage the surfaces. Do not use alcohol, alcohol-based or ammonia-based cleaners as they may damage or dissolve the plastic components or soften the decals or decal adhesive. To clean grip tape, use a wet coarse bristle brush to scrub any dirt stuck to the surface and let dry.

❑ How to Ride

Place one foot on the baseboard, push forward with the other foot. Steer. For enhanced cornering, lean slightly into the direction of the turn. For controlled stops, apply the brake by stepping on the rear fender/brake. Practice applying the brake at various speeds and in an open area free from obstructions before riding around others.

⚠ WARNING: Wheelies and other stunt-type riding reduces your ability to maneuver and control your scooter. Take the necessary precautions, such as wearing appropriate protective gear and practice in an area safe for stunt riding and free from obstructions.

SAFETY REMINDERS

PRE-RIDE CHECKLIST



Loose Parts /Tire Care

Check and secure all fasteners before every ride. Make sure the collar clamp is locked properly in place before riding. Inspect tires for signs of wear or damage. Measure and adjust the PSI of the tires accordingly. Do not exceed 60 PSI.



Replacement Parts

Replace worn or broken parts immediately. Visit www.razor.com for replacement parts.



Safety Gear

Always wear proper protective equipment, such as an approved safety helmet, elbow pads and kneepads. Always wear shoes (lace-up with rubber soles). Keep shoelaces tied and out of the way of the wheels and never ride barefoot or in sandals.



Be Careful!

You will see people on TV and maybe even people you know doing tricks and stunts. These are people who have been practicing on scooters for a very long time. Don't try something until you are ready. Avoid steep inclines and don't ride too fast — you can lose control and fall. Never ride in traffic or on the street and watch your surroundings for pedestrians, bikers, boarders and skaters.

Maintain a hold on the handlebars at all times.



DO NOT RETURN TO STORE

This does not affect your statutory rights.

Failure to follow these instructions may damage your product and void your warranty.

WARRANTY

Razor Limited Warranty

The manufacturer warrants this product to be free of manufacturing defects for a period of 6 months from date of purchase. This Limited Warranty does not cover normal wear and tear, or any damage, failure or loss caused by improper assembly, maintenance, or storage.

This Limited Warranty will be void if the product is ever

- used in a manner other than for recreation;
- modified in any way;
- rented.

The manufacturer is not liable for incidental or consequential loss or damage due directly or indirectly to the use of this product.

The Razor RDS does not come with an extended warranty. If you have purchased an extended warranty, it must be honored by the store at which it was purchased.

For your records, save your original sales receipt with this manual.

CUSTOMER SERVICE INFO

Printed in China for Razor USA LLC.

UNITED STATES MAILING ADDRESS:
RAZOR USA LLC
P.O. Box 3610
Cerritos, CA 90703
Tel: 866-467-2967

DISTRIBUTED IN THE UK BY:
re:creation Ltd,
2 Meadows Business Park
Station Approach
Blackwater
Camberley
Surrey
GU17 9AB
Tel: 0118 973 6222 Fax: 0118 973 6220
Email: sales@recreationltd.co.uk

DISTRIBUTED IN AUSTRALIA BY:
FUNTASTIC LIMITED.
Level 2
Tower 2
Chadstone Place
1341 Dandenong Rd
Chadstone
3148
Customer Service: 1800 244 543